

Article number: 20652041

Description: E+G Centring bore clamp GN 411.2-54.5-K

Measures

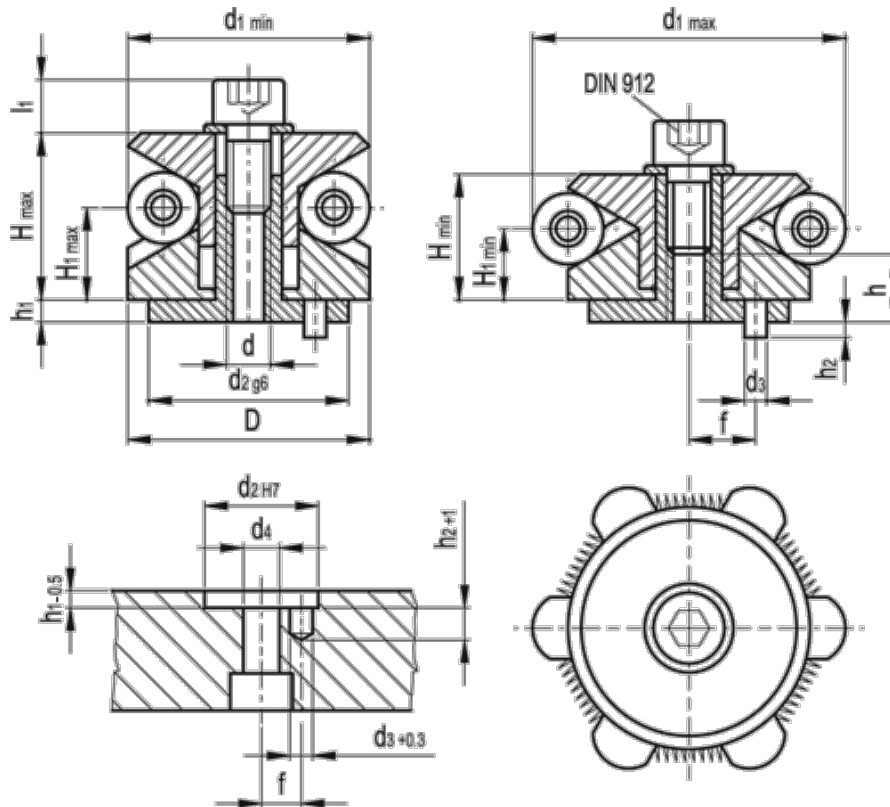

Clamping force (kN) = 8.00	d4 = 10.5	H min = 28.4
Clamping points = 6	f +/-0.1 = 11.0	l1 = 13.5
D = 54.5	h1 = 5.0	Weight (g) = 650
d = M10	H1 max = 20.7	
d1 max = 70.5	H1 min = 16.0	
d1 min = 54.5	h2 = 7.0	
d2 g6/H7 = 45	H max = 37.7	
d3 = 5.0	h min = 15	